

Electromechanical lock SERIE 2700 RESTYLING

Instructions for use and for assembly



SECUREMME®

LIVING YOUR SECURITY

Thanks you for the confidence shown by choosing this product and invites the purchaser to read the instructions for use of the system.

SECUREMME S.R.L. | Via del lavoro 6/8 | 23854 OLGINATE (LC) ITALY
TEL. ++39. 0341.605.243 | FAX ++39.0341.605.486
www.securemme.it | E-mail: info@securemme.it

INSTALLATION

For the installation of the lock in the door, you need some holes as follows:

- hole in the door and in its holder for the passage of **DOOR CABLE** through passerby tool guide (picture 1),
- hole on the external panel for the passage of **EXTERNAL KEYBOARD CABLE**, considering the length of the same cable,
- hole \varnothing 19 mm in the door and its holder for magnetic sensor (page 3).

THE CABLES PACKING CONTAINS :

N° 1 **DOOR CABLE** (length 3 m)

N° 1 **MAGNETIC SENSOR CABLE** (length 1,4 m) + **MAGNET**

N° 1 **EXTERNAL KEYBOARD CABLE** (length 60 cm)

Connect the cables as indicated in page 4

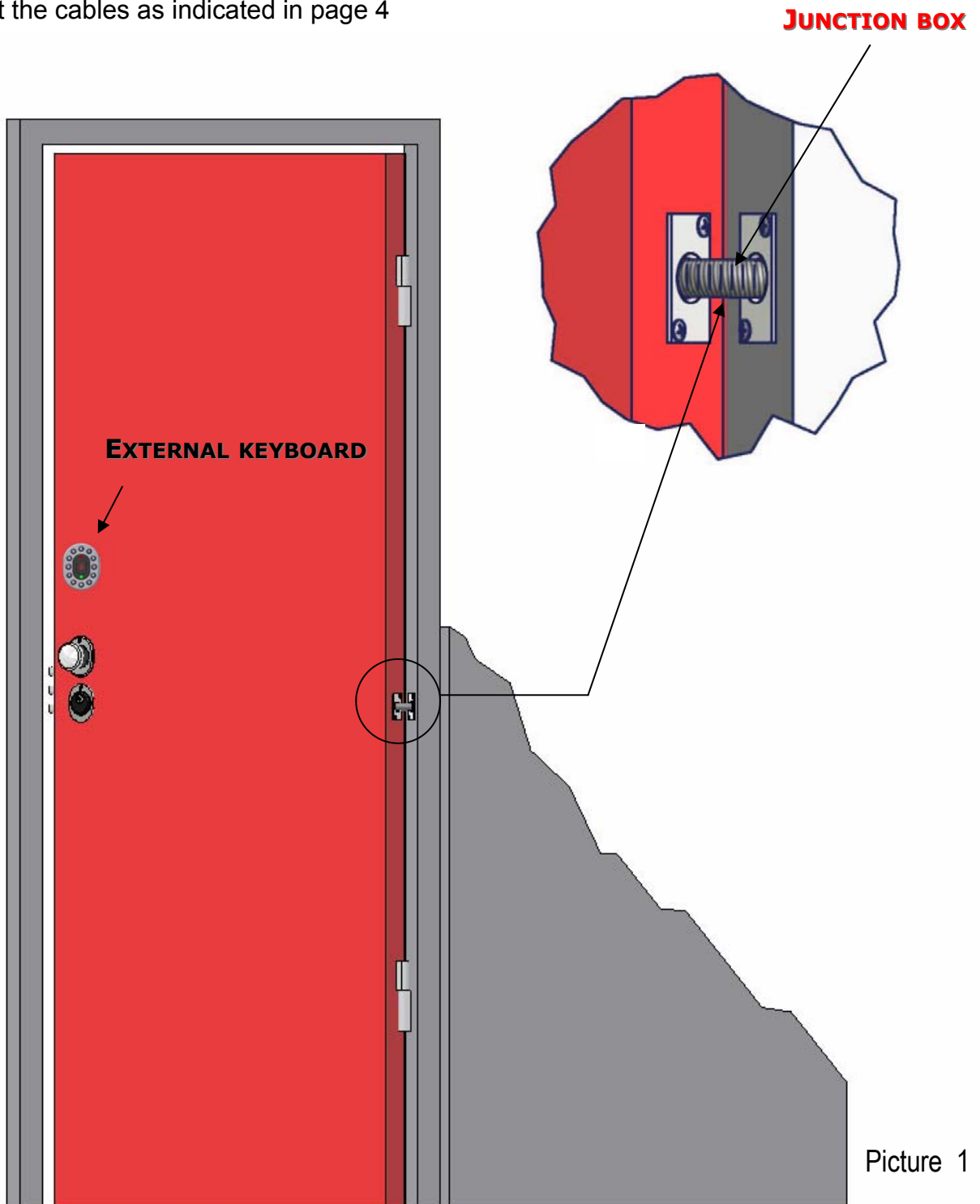

Picture 1

CONNECTIONS

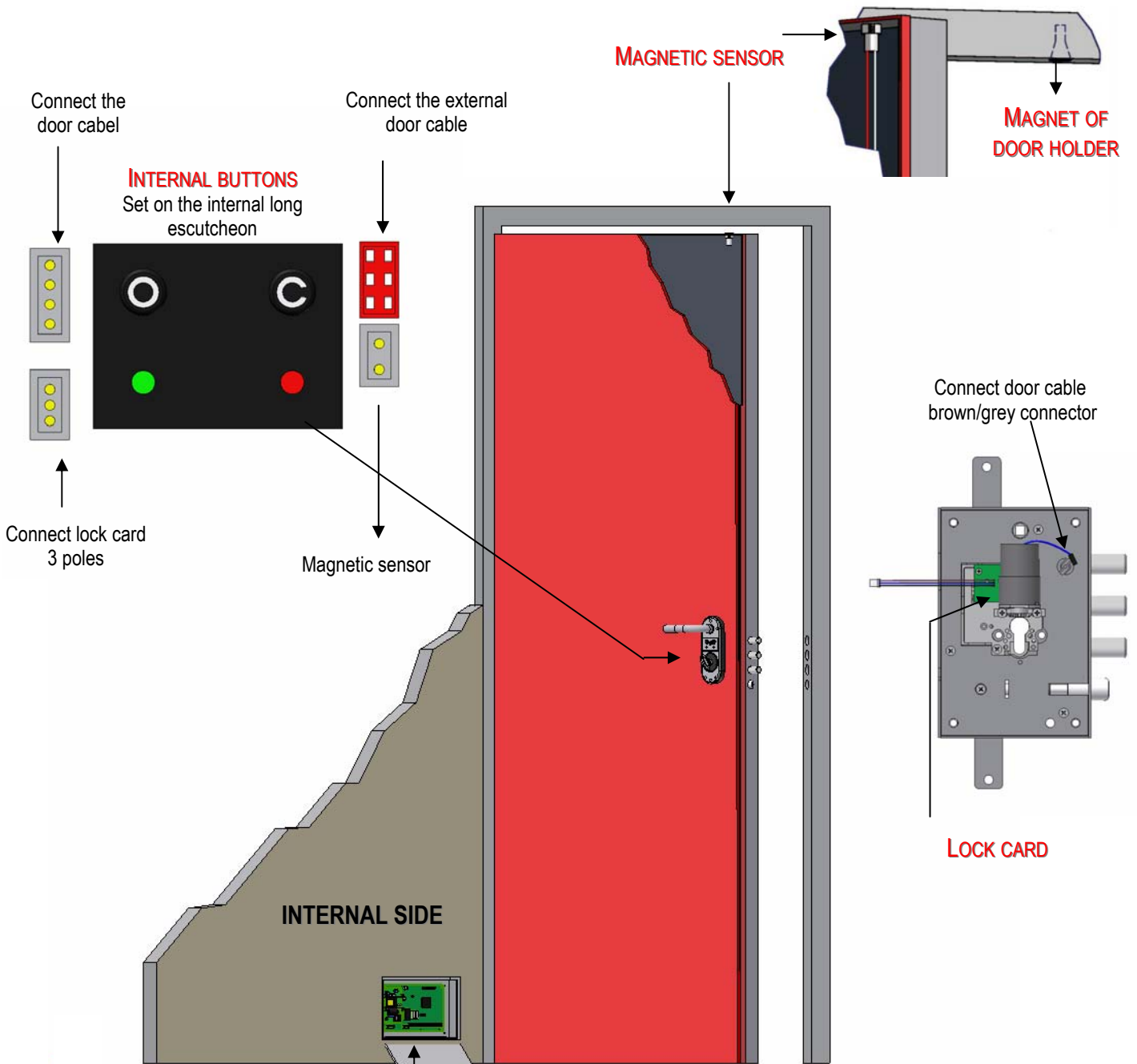

MASTER CARD

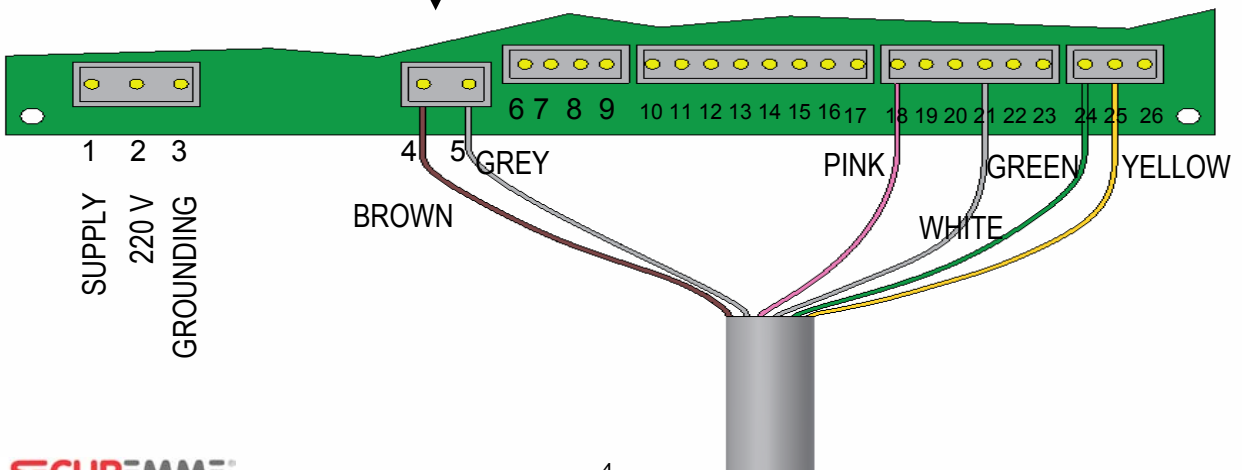

MASTER CARD

THE MASTER CARD ALLOWS TO “SERIE 2700 RESTYLING” NEW OPENING SYSTEMS AND NEW APPLICATIONS AS FOLLOWS :

- opening through button (connect 12-13)
- closing through button (connect 14-15)
- opening through entryphone (connect 16-17)

It is possible to connect the magnetic sensor with the holder cables and the magnet in the door. In this case connect with 10-11 of the card.

To get a signal contemporary with the opening of the lock, for example lighting, connect 6-7.

To get a signal of opening for alarm system, connect 8-9.

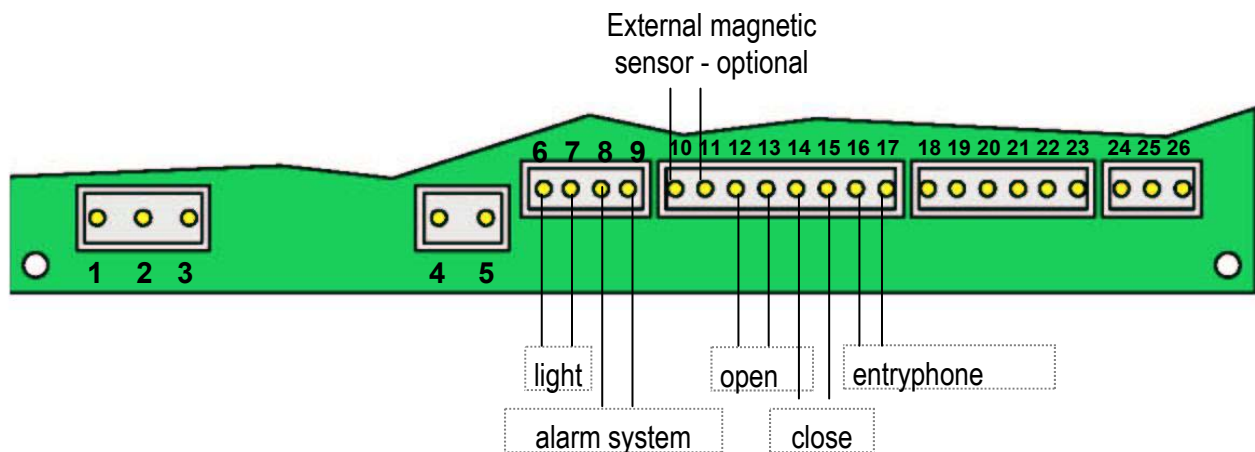
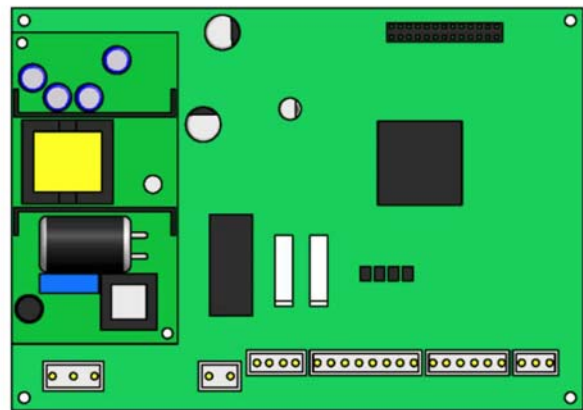
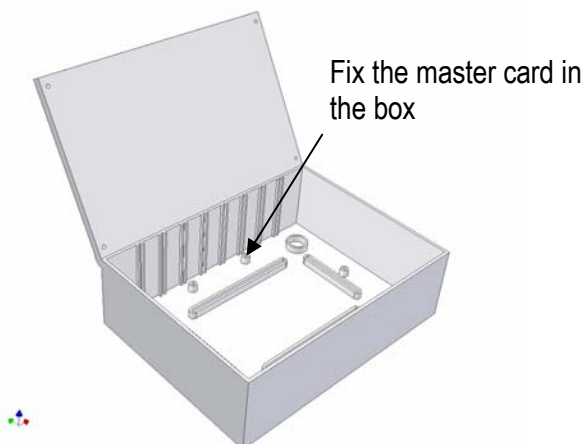

TECHNICAL DETAILS

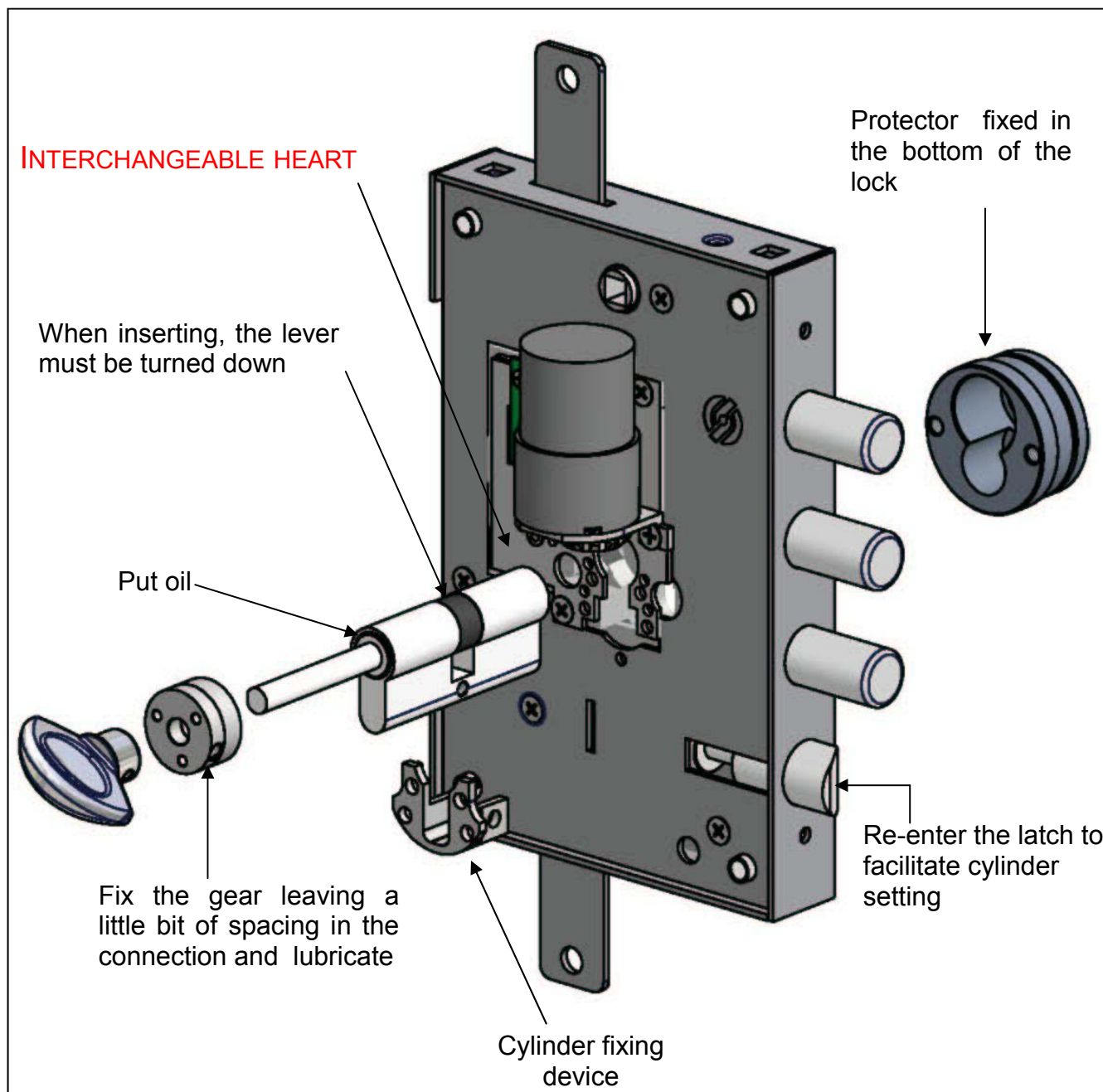

THE GOOD WORKING OF THE LOCK IS GUARANTEED WITH THE USE OF SECUREMME CYLINDER

- LOCK WITH ELECTROMECHANICAL MECHANISM.
- OPERATION BY KEY, TRANSPONDER , KEYBOARD, REMOTE OPENING THROUGH BUTTONS AND ENTRYPHONE.
- INTERCHANGEABLE HEART: ALL ELECTRONIC COMPONENTS ARE IN THE HEART OF THE LOCK. IN CASE OF NO-OPERATION, YOU CAN SIMPLY REPLACE THE HEART WITHOUT REMOVING THE PANEL AS IN USUAL MECHANICAL LOCKS.
- MACHANICAL OPERATION BY EUROPEAN CYLINDER
- MOTORIZED ELECTRONIC OPERATION

INSTRUCTION FOR USE

STANDARD SUPPLY

1. Electromechanical lock art. 2700/2730
2. Electronic card and box
3. Internal buttons (O) and (C)
4. Junction box
5. External keyboard
6. n. 3 TRANSPONDER in key-holder format
7. n. 1 MASTER in credit card format
8. Cables packing
9. Gear for the cylinder

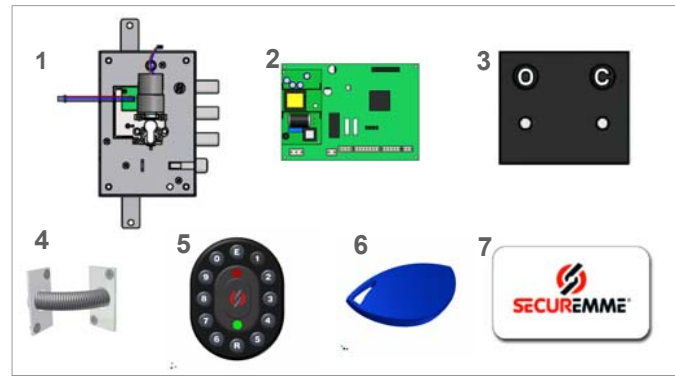

THE MASTER AND TRANSPONDER ARE SUPPLIED ALREADY WORKING AND THE LOCK IS READY FOR THE USE.

REMEMBER TO PERSONALIZE THE CODE ON THE KEYBOARD

IN CASE OF A POWER CUT NO PROBLEM: THE LOCK NORMALLY WORKS WITH THE KEY FROM THE OUTSIDE AND WITH THE HANDLE FROM THE INSIDE!

OPENING OF THE DOOR

From outside the possible methods are:

1. **KEYBOARD:** typing secret code on the keyboard, then press E;
2. **TRANSPONDER:** pass over the keyboard;
3. **KEY**



Keyboard



Transponder

From inside the possible methods are:

1. **PRESSING BUTTON O** (Open) under the handle
2. Opening through the **KNOB**

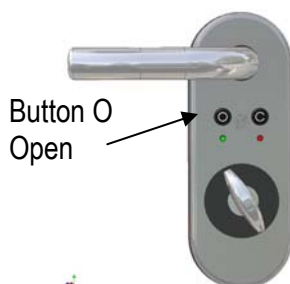

CLOSING OF THE DOOR

From outside the possible methods are:

1. **1 E:** door closed, type 1 E on the keyboard
2. **AUTOMATIC CLOSING:** if activated (*see modify functions*), the lock close automatically when the door leaf is shut.
3. **BUTTON C:** type the button C from the inside and close the door. The lock close automatically.
4. **KEY**

From inside the possible methods are:

1. Press the button **C** inside of the door;
2. Closing through **KNOB**;
AUTOMATIC CLOSING (if activated).

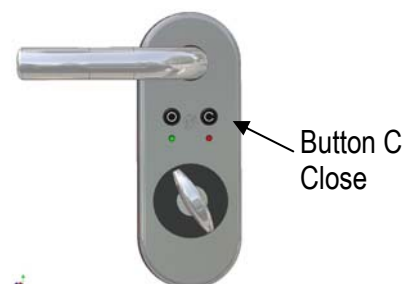

TO MODIFY FUNCTIONS

PERSONALIZATION OF KEYBOARD (MODIFY CODE)



The keyboard has been pre-set with the code **12345**. To insert own code (maximum 10 digits) proceed as follows:

WITH DOOR OPEN

- 1- Type the currently active code and press **R** (Re-program);
- 2- While the red and green leds are flashing type new code and press **R**;
- 3- Wait for the leds to flash, insert the new code again and press **R**.

NOW YOUR SECRET CODE HAS BEEN INSERTED.

If the procedure is not correct allow the maximum time (10 seconds) to lapse and the modification will be annulled.

TO VALIDATE THE MASTER.



Master in standard supply already working

The ELECTRONIC MASTER CARD opens the lock, it is the first to be validated and is needed to activate the other TRANSPONDER (max 90 pcs). We therefore advise you to keep it in a safe place.

DOOR OPEN

- 1- Press the buttons **O** and **C** simultaneously and release;
- 2- When the both leds are flashing place the electronic MASTER card on the keyboard;
- 3- Wait a few seconds, the green led will remain on.



TO ACTIVATE TRANSPONDER



Transponder in standard supply already working

DOOR OPEN

- 1- Press the buttons **O** and **C** simultaneously and release;
- 2- Place the MASTER card (previously validated) on the keyboard, the leds will flash;
- 3- Press the internal button **O**; the green led only will flash;
- 4- Place the TRANSPONDER to be validate on the keyboard, the green led will remain on for 3"

NOW THE TRANSPONDER IS ACTIVATED

- 5- The led will begin flashing again, repeat the above operation with another TRANSPONDER, the green led will remain on for 3 sec.

THE SECOND TRANSPONDER IS NOW ACTIVATED

- 6- Continue in this way until all TRANSPONDER available have been activated, then allow the leds to flash for the maximum 10 sec. to terminate.

When you have finished activating the electronic keys it is advisable to keep the card in safe place and use it to open the door only if necessary.

TO PERSONALIZE THE AUTOMATIC LOCKING FUNCTION

When the function is activated it is possible to operate the lock simply by closing the door. At the time of production the locks are not validated for this function. In order to activate follow these instructions:

DOOR CLOSED

- 1- Press the buttons **O** and **C** simultaneously and release;
- 2- Press the button **C** 6 times;
- 3- Now the automatic locking function inverts, if not active now get active and viceversa;
- 4- Check that the new function is operative by opening and closing the door. If the sequence is not completed the procedure will automatically be interrupted (maximum 10 seconds).



USE OF MASTER TRANSPONDER

The master transponder is an usual transponder which besides the open function, is endowed with a special closing system deactivating all electronic controls. The lock closed by master transponder doesn't work neither by all other transponder, nor by keyboard or other applications anymore.





NOW THE LOCK OPENS ONLY BY MASTER TRANSPONDER

OPENING THE DOOR BY MASTER TRANSPONDER ALL APPLICATIONS RETURN OPERTIVE.

Remember to differentiate the master transponder from all the other ones.

TO ACTIVATE A MASTER TRANSPONDER



DOOR OPEN:

- 1- Press OPEN (O) and CLOSE (C) internal buttons simultaneously 
- 2- Place the MASTER  near the external keyboard  (internal led will flash).
- 3- Press the button OPEN (O).
- 4- Keep the external button R pushed and place the transponder to be   activated as master near the keyboard (green led remains on)
- 5- When the green led flashes again, activate other master transponder or wait the flashing to stop

USE OF MASTER TRANSPONDER

DEACTIVATION OF THE LOCK

DOOR CLOSED

Press R  and place the master transponder near the keyboard 

the bolt closes (if not closed yet).

At this point the lock doesn't operate electronically anymore and the led will flash as confirmation.

ACTIVATION OF THE LOCK

Only a master transponder can open the lock, which operates regularly again .

SPECIAL CIRCUMSTANCES

DEACTIVATING A TRANSPONDER

THIS PROCEDURE IS CARRIED OUT WHEN A TRANSPONDER IS LOST



Remember that when a TRANSPONDER is deactivated all the others are automatically deactivated as well.

Only the MASTER key re-  main active and this will subsequently allow the other TRANSPONDER to be reactivated with new codes.



DOOR OPEN

- 1- Press buttons open **O** and close **C** simultaneously and release; 
- 2- Place the MASTER on the keyboard;  
- 3- Led will flash, press the button **C**;
- 4- The red led will flash (all active codes will be deactivated) press the close button **C** again;
- 5- Now all TRANSPONDER have been deactivated while the MASTER is still active;
- 6- It will therefore be possible to reactivate TRANSPONDER with new codes (thus deactivating the lost key).

LOSS OF MASTER CARD

What do you need? The majority of TRANSPONDER.  

DOOR OPEN

- 1- Press buttons open **O** and close **C** and release; 
- 2- Place a TRANSPONDER on the   keyboard; the green led will light up. Repeat the operation for a number of TRANSPONDER superior to 50% total number of activated TRANSPONDER (example: if the total number is 3, place 2 on the keyboard);
- 3- When the number has been reached the led will flash for 10 sec. **NOW ALL THE TRANSPONDER AND THE MASTER HAVE BEEN DEACTIVATED.** In order to re-activate them with new codes follow the previous instructions.

RESET OF KEYBOARD CODE

You use this application in the case you forget your personal code.

DOOR OPEN

- 1- Press buttons OPEN **O** and CLOSE **C** simultaneously and release; 
 - 2- Place the MASTER on external keyboard;  
 - 3- While 2 led of internal buttons are lighting, press "**R**" on the keyboard;
- THE CODE 12345 WILL BE ACTIVED AGAIN. THE KEYBOARD IS READY TO BE PERSONALIZED WITH NEW CODE AGAIN.

TERMS OF WARRANTY

This product is guaranteed against malfunctions due to manufacturing defects. For the warranty to be valid, you have to fill out the card with the owner's data and store it with the receipt or tax document proving the date of purchase. The warranty covers free replacement or repair of part deemed defective due to manufacturing defects, excluding shipping charges.

The warranty does not cover:

- damage caused by installation not conforming to the instructions in this manual.
- operation not corresponding to methods of use described herein.
- visible, electrical and electronic parts damaged due to negligence, due to maintenance performed by unauthorized staff, careless transport, and in general due to reasons that cannot be attributed to manufacturing defects.

Payment of direct and/or in direct damages to persons or property resulting from suspended use of the system is excluded. If technical assistance should be needed on site, the customer is required to pay a fee for travel costs of the authorized technical staff.

OWNER'S DETAILS

TO FILL AND STORE WITH PROOF OF PAYMENT; TO BE USED IN CASE OF MALFUNCTIONS

NAME _____ SURNAME _____

ADDRESS _____

ZIP CODE _____ TOWN _____

COUNTRY _____ NATION _____

TEL _____ FAX _____ E-MAIL _____

SIGNATURE _____